





FEATURES	
Technology	Basic
Energy Metering	No
Metering per Input Line	No
Metering per Output Receptacle	No
Remote Outlet Switching	No
Ethernet Port	No
Networking Protocols	No
PDU Cascading	No
Power Share	No
Display	No
Residual Current Monitoring	No
USB Ports	No
Environmental Sensors	No
INPUT	
Plug	IEC60309 3P+N+E 6h 32A 380-415V
Lead Length	3 meter
Cable Type	H07RN-F5G4.0 mm ²
Max. Input Load	32A
Rated Input Voltage	380-415V three phase
Frequency	50-60Hz
Power Capacity	22.1kW
OUTPUT	
Rated Output Voltage	190-250V Single phase
Output Types	36 IEX (C13/C19) combo (Max rate 16A) EN61984+UL498 certified
Overload Protection	(6) 1 Pole Carling 16A L Series L31-B0-24-616-H12-D3
CHASSIS	
Dimensions (W x D x H)	1542 x 55 x 55.4 mm
Color	RAL 9004 black powder coat
Mounting Options	4 mounting options (see page 2)
Required Torque for Mounting Screws	≥2.54N·m (25.9kgf·cm or 22.4 in·lbs)
OPERATING ENVIRONMENT	
Temperature Range	0° to 60° C (30° to 140° F)
Humidity	0 - 95 %
Elevation	0 - 4000 Meters
CONFORMANCE	
IEC 62368-1 (Third Edition)	
   	



C13 locking, compatible with standard C14 plug, C14 V-Lock plug

C13 Lock Part

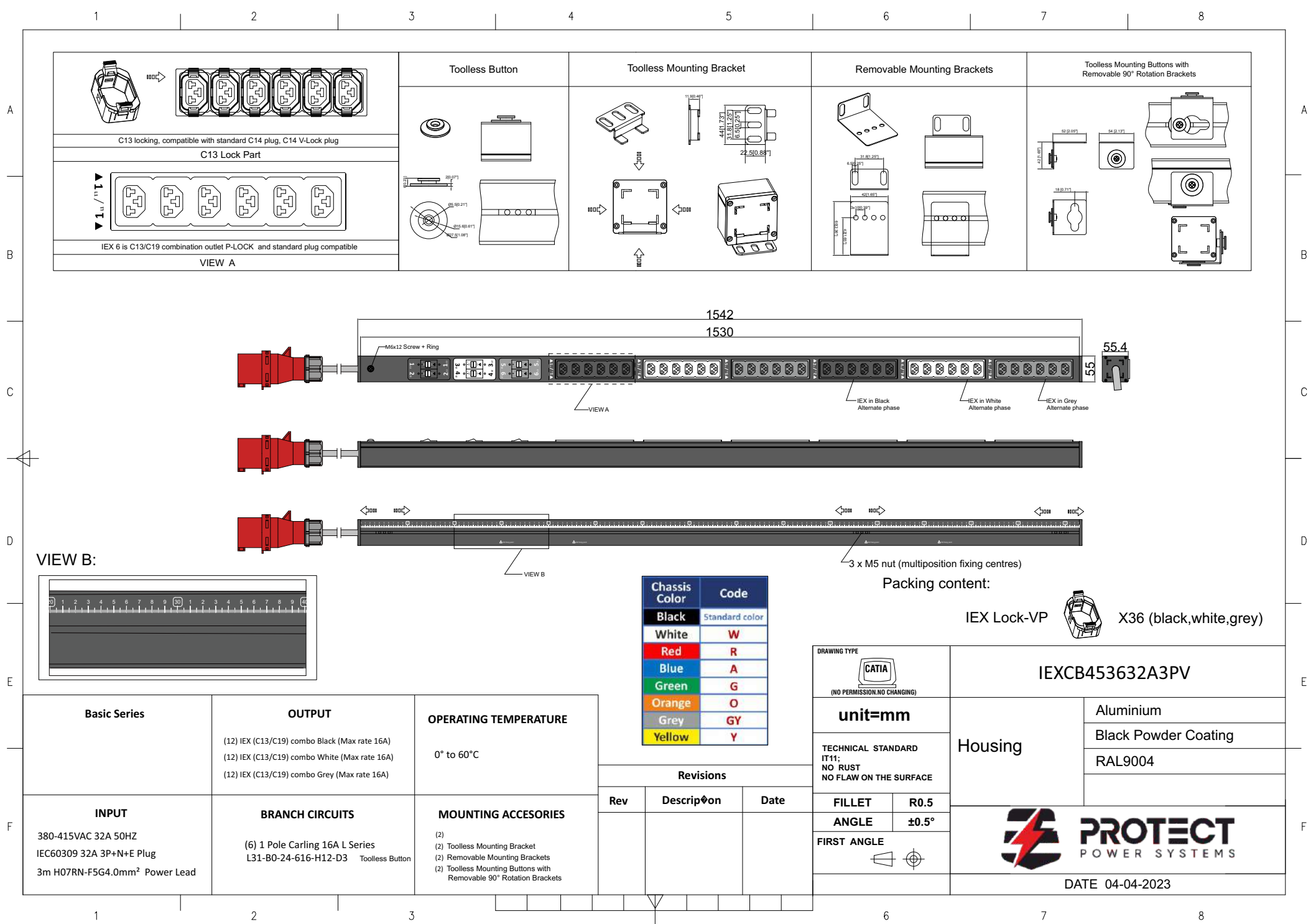
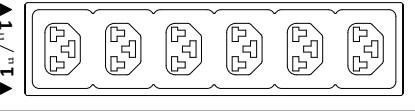

IEX 6 is C13/C19 combination outlet P-LOCK and standard plug compatible

VIEW A

Toolless Button

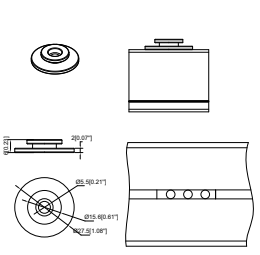

Toolless Mounting Bracket

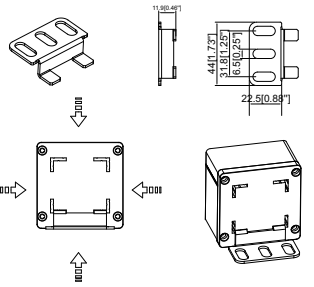

Removable Mounting Brackets

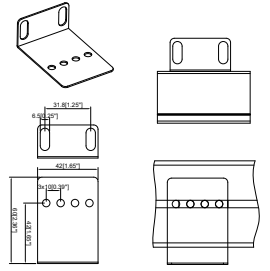

Toolless Mounting Buttons with Removable 90° Rotation Brackets

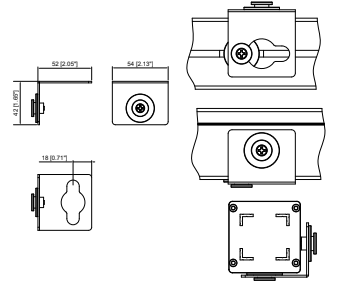

1542
1530

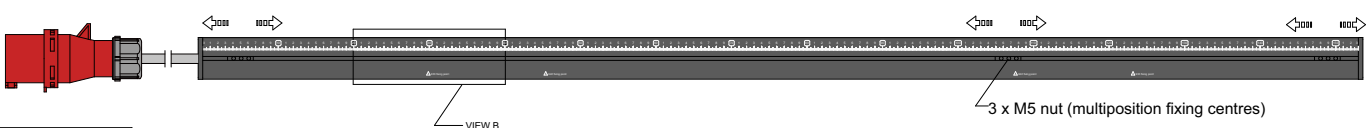
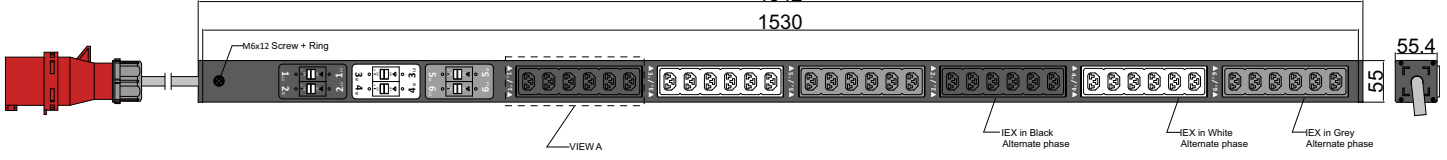

VIEW B:

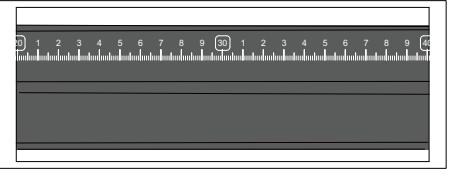



Chassis Color	Code
Black	Standard color
White	W
Red	R
Blue	A
Green	G
Orange	O
Grey	GY
Yellow	Y

Packing content:

IEX Lock-VP  X36 (black,white,grey)

Basic Series INPUT 380-415VAC 32A 50HZ IEC60309 32A 3P+N+E Plug 3m H07RN-F5G4.0mm ² Power Lead	OUTPUT (12) IEX (C13/C19) combo Black (Max rate 16A) (12) IEX (C13/C19) combo White (Max rate 16A) (12) IEX (C13/C19) combo Grey (Max rate 16A)	OPERATING TEMPERATURE 0° to 60°C	Revisions		
			BRANCH CIRCUITS (6) 1 Pole Carling 16A L Series L31-BO-24-616-H12-D3 Toolless Button	MOUNTING ACCESSORIES (2) (2) Toolless Mounting Bracket (2) Removable Mounting Brackets (2) Toolless Mounting Buttons with Removable 90° Rotation Brackets	Rev

DRAWING TYPE  (NO PERMISSION, NO CHANGING)	IEXCB453632A3PV	
unit=mm TECHNICAL STANDARD IT11; NO RUST NO FLAW ON THE SURFACE	Housing	Aluminium Black Powder Coating RAL9004
FILLET R0.5 ANGLE ±0.5° FIRST ANGLE		
PROTECT POWER SYSTEMS DATE 04-04-2023		

- Low cost locking solution t both ends
- Different colors available
- Patented IEX locking system
- Locking sleeve for C13 and C19 plugs
- VDE, UL approved

IEX PATENTED LOCKING SOCKET - POWER CORD SOLUTION



C14 - C13 Sleeve

H05VV-F3G1 mm²

Color	0,5M	1M	2M
Black	4	4	4
Red	4	4	4
Blue	4	4	4

C14PLOCK - C13 Sleeve

H05VV-F3G1 mm²

Color	0,5M	1M	2M
Black	4	4	4
Red	4	4	4
Blue	4	4	4

C20PLOCK - C19 Sleeve

H05VV-F3G1,5 mm²

Color	1M	2M
Black	4	4
Red	4	4
Blue	4	4

C20PLOCK - C13 Sleeve

H05VV-F3G1 mm²

Color	1M	2M
Black	4	4
Red	4	4
Blue	4	4

1

2

3

4

5

6

7

8

A

B

C

D

E

F

A

B

C

D

E

F

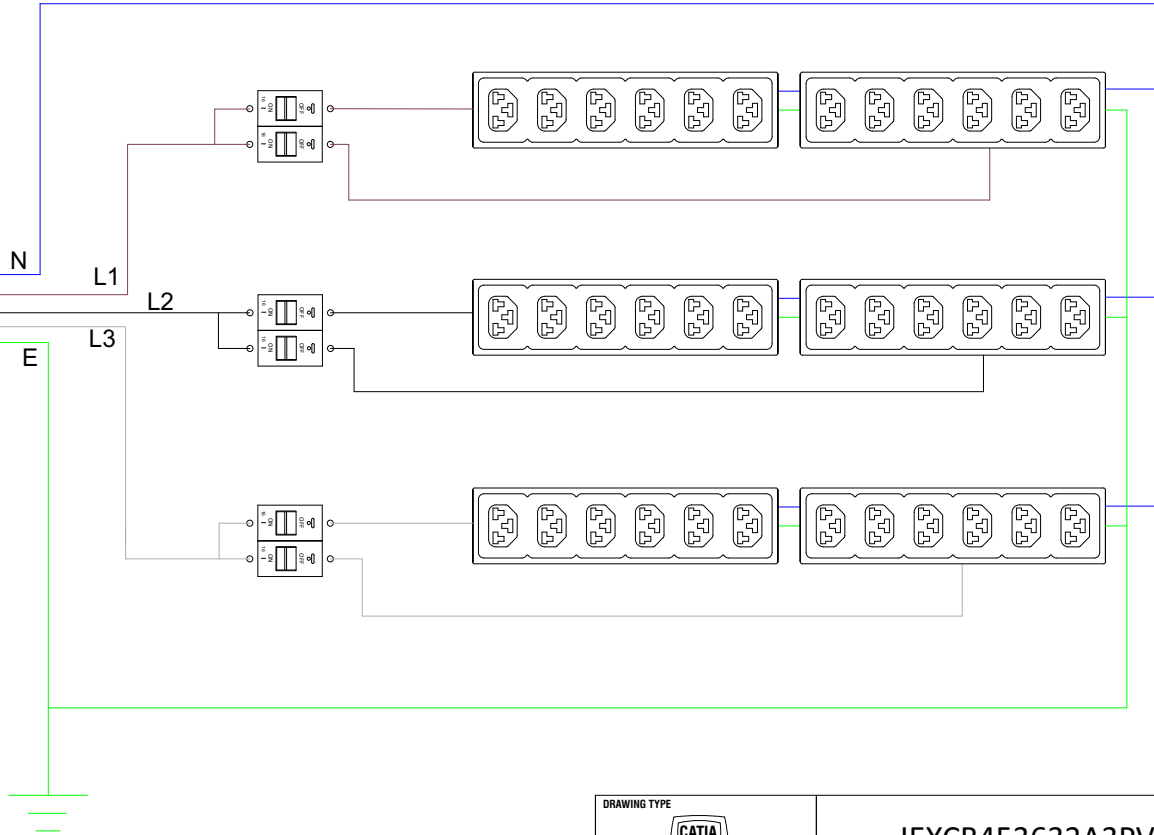
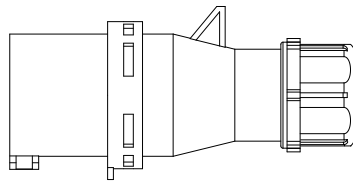
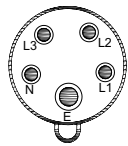

DRAWING TYPE		IEXCB453632A3PV-wiring	
 <small>(NO PERMISSION.NO CHANGING)</small>		Housing	
unit=mm			
TECHNICAL STANDARD IT11; NO RUST NO FLAW ON THE SURFACE			
FILLET	R0.5		
ANGLE	±0.5°		
FIRST ANGLE			
		DATE 27-05-2021	

1

2

3

6

7

8

QTY	Part No.
12	IEXLOCKB
12	IEXLOCKW
12	IEXLOCKG

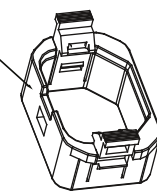

QTY	Part No.
3	BO002

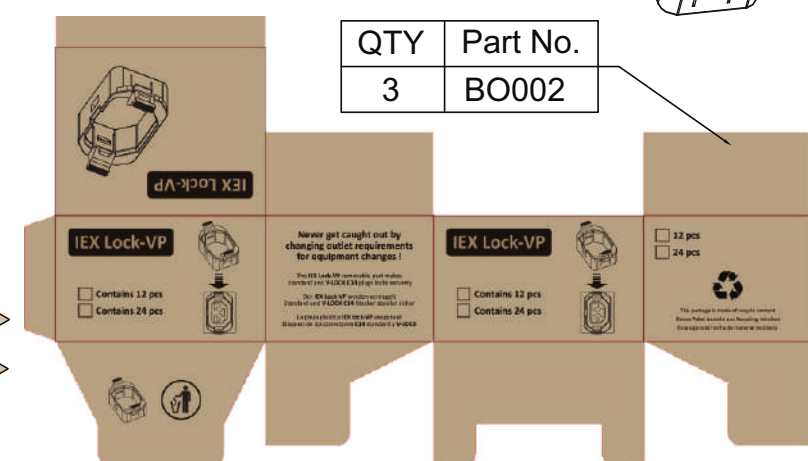

Part No.
PP029

Part No.
PP080-4

Part No.
PP030-4

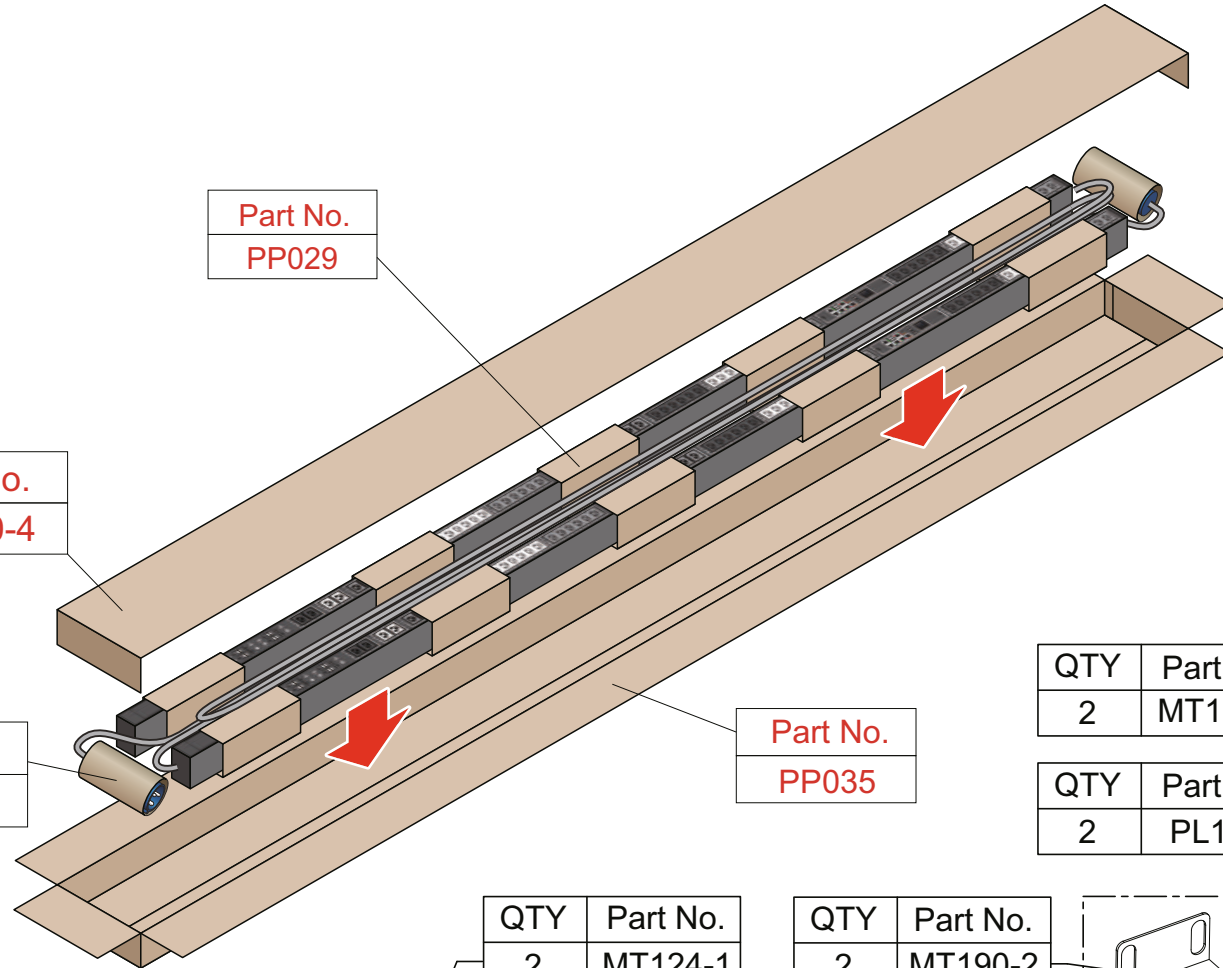

Part No.
PP035

QTY	Part No.
2	MT190-1

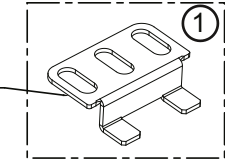

QTY	Part No.
2	MT124-1

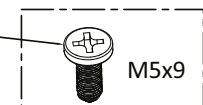

QTY	Part No.
2	PL178

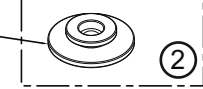

QTY	Part No.
2	MT124-1

QTY	Part No.
2	MT190-2

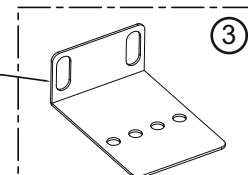

QTY	Part No.
6	MT124



QTY	Part No.
2	PL178

QTY	Part No.
2	MT190-3

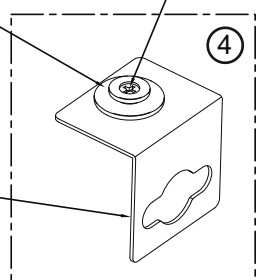

PK023
Section 22.5x7.2 cm Length 175 cm

Weight: 6kg(2 PDU)