





FEATURES	
Technology	PIM Lite (Per Inlet Monitoring)
Energy Metering	Voltage(V), Current(A), Active Power(kW), Real Power (KVA), Power Factor, kWh
Metering per Input Line	Yes (Branch Circuit and Total Current) Accuracy 1%
Metering per Output Receptacle	No
Remote Outlet Switching	No
Ethernet Port	10/100Mbps Ethernet
Networking Protocols	DHCP, IPv4 and IPv6, DNS, http / https, SSHv.2, SNMP v1 / v2c / v3, SNMP TRAPS / SETS / GETS, SMTP, Modbus , Telnet, TCP, RADIUS, Syslog, TLS 1.2, SNTP, ARP, ICMP, ICMPv6, UDP, NDP
PDU Cascading	No
Power Share	No
Network Controller	4 Digital-7 Segment Display LED
Residual Current Monitoring	No
USB Ports	No
Environmental Sensors	All in one Temperature and Humidity sensor with 2 digital inputs (for connect air flow, door sensor, water leak, smoke detector and Vibration sensor) plug and play bus allows to connect 8 EMD devices in one PDU
INPUT	
Plug	IEC60309 3P+N+E 6h 16A 380-415V
Lead Length	3 meter
Cable Type	H07RN-F5G2.5 mm ²
Max. Input Load	16A
Rated Input Voltage	380-415V three phase
Frequency	50-60Hz
Power Capacity	11kW
OUTPUT	
Rated Output Voltage	190-250V Single phase
Output Types	36 IEX (C13/C19) combo (Max rate 16A) EN61984+UL498 certified
Overload Protection	None
CHASSIS	
Dimensions (W x D x H)	1512 x 55 x 55.4 mm
Color	RAL 9004 black powder coat
Mounting Options	4 mounting options (see page 2)
Required Torque for Mounting Screws	≥2.54N·m (25.9kgf·cm or 22.4 in·lbs)
OPERATING ENVIRONMENT	
Temperature Range	0° to 60° C (30° to 140° F)
Humidity	0 - 95 %
Elevation	0 - 4000 Meters
CONFORMANCE	
IEC 62368-1 (Third Edition)	
   	



Chassis Color	Code
Black	Standard color
White	W
Red	R
Blue	A
Green	G
Orange	O
Grey	GY
Yellow	Y



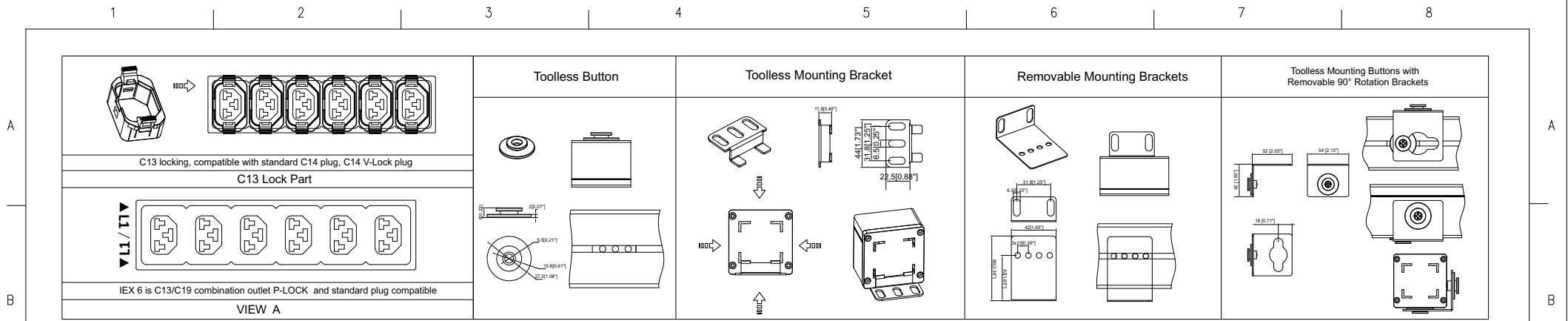
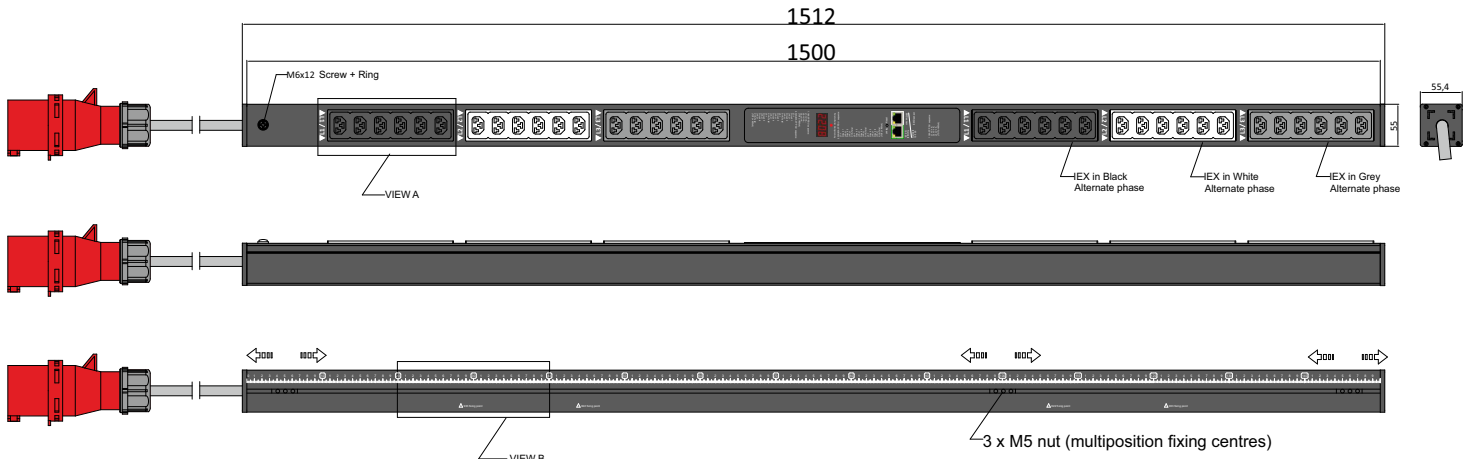

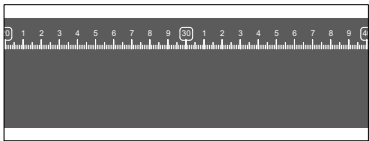
VIEW B:



Packing content:

IEX Lock-VP  X36 Red

PIM Lite Series Inlet Power Monitoring Environmental Monitoring	OUTPUT (12) IEX (C13/C19) combo Black (Max rate 16A) (12) IEX (C13/C19) combo White (Max rate 16A) (12) IEX (C13/C19) combo Grey (Max rate 16A)	OPERATING TEMPERATURE 0° to 60°C	Revisions		
			Rev	Description	Date
INPUT 380-415VAC 16A 50HZ IEC60309 16A 3P+N+E Plug 3m H07RN-F5G2.5mm ² Power Lead	BRANCH CIRCUITS	MOUNTING ACCESSORIES (2) Toolless Button (2) Toolless Mounting Bracket (2) Removable Mounting Brackets (2) Toolless Mounting Buttons with Removable 90° Rotation Brackets			

DRAWING TYPE  (NO PERMISSION, NO CHANGING)		LIGHTS36V4516A3P	
unit=mm		Housing	Aluminium
TECHNICAL STANDARD IT11; NO RUST NO FLAW ON THE SURFACE			Black Powder Coating
Fillet R0.5			RAL9004
ANGLE ±0.5°			
FIRST ANGLE 			
DATE 01-09-2021			

- Low cost locking solution at both ends
- Different colors available
- Patented IEX locking system
- Locking sleeve for C13 and C19 plugs
- VDE, UL approved

IEX PATENTED LOCKING SOCKET - POWER CORD SOLUTION



C14 - C13 Sleeve

H05VV-F3G1 mm²

Color	0,5M	1M	2M
Black	✓	✓	✓
Red	✓	✓	✓
Blue	✓	✓	✓

C14PLOCK - C13 Sleeve

H05VV-F3G1 mm²

Color	0,5M	1M	2M
Black	✓	✓	✓
Red	✓	✓	✓
Blue	✓	✓	✓

C20PLOCK - C19 Sleeve

H05VV-F3G1,5 mm²

Color	1M	2M
Black	✓	✓
Red	✓	✓
Blue	✓	✓

C20PLOCK - C13 Sleeve

H05VV-F3G1 mm²

Color	1M	2M
Black	✓	✓
Red	✓	✓
Blue	✓	✓

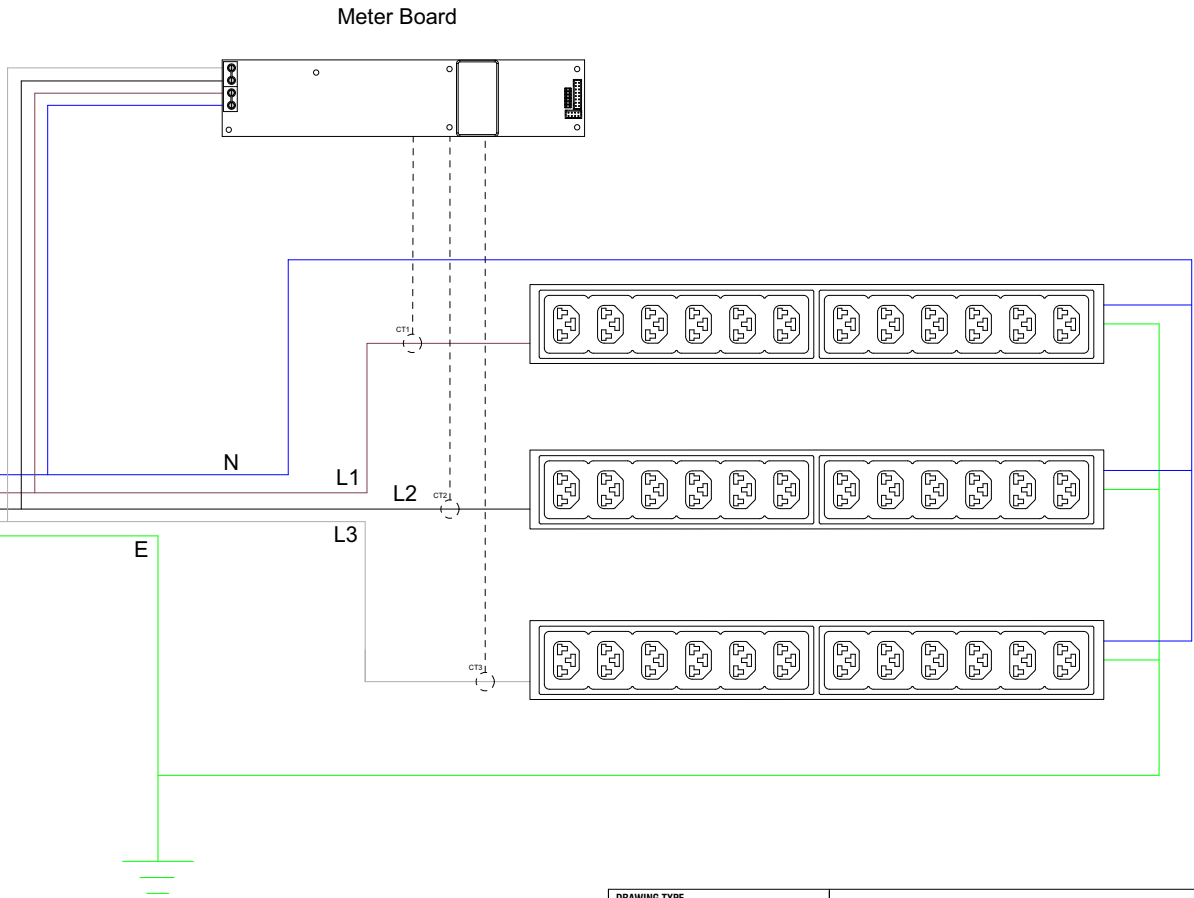
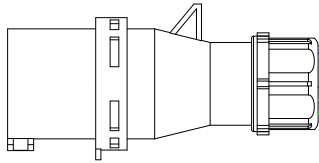
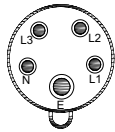

DRAWING TYPE	
(NO PERMISSION, NO CHANGING)	
unit=mm	
TECHNICAL STANDARD IT11; NO RUST NO FLAW ON THE SURFACE	
FILLET	R0.5
ANGLE	±0.5°
FIRST ANGLE	

LIGHTS36V4516A3P-wiring	
Housing	Aluminium
	Black Powder Coating
	RAL9004
DATE 09-03-2021	